

VR CNC Turning

CNC MACHINE CONTROL SOFTWARE

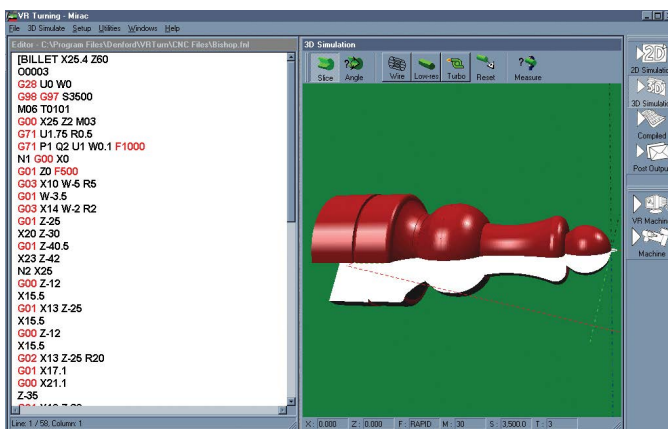
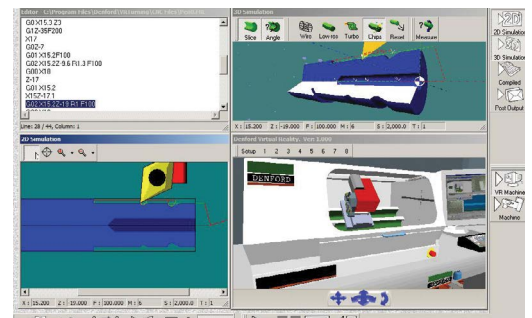
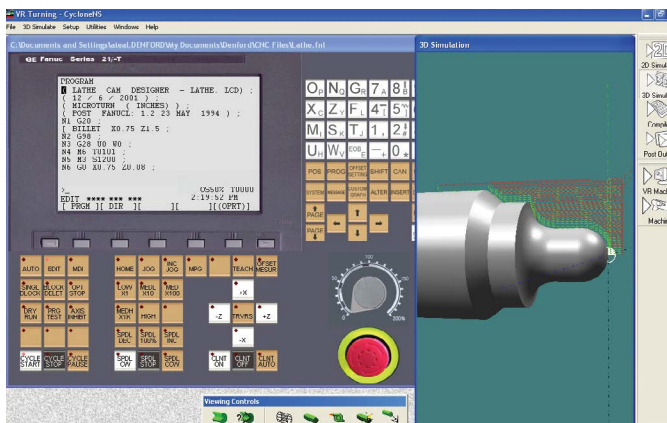
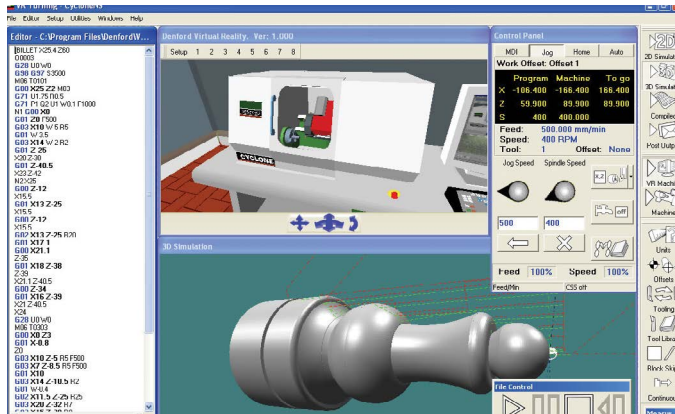

VR CNC Turning is a Virtual Reality based CNC programming software package offering full machine control and Virtual Reality simulation of CNC Lathes. Features include customisable docking toolbars, comprehensive tooling management, colour formatting of NC code & powerful NC code modification options.

VR CNC Turning

PROGRAMMING FEATURES

- Customisable docking toolbars.
- Comprehensive tooling management.
- Colour formatting of NC code.
- Powerful NC Code modification options.
- Context sensitive G&M code help.

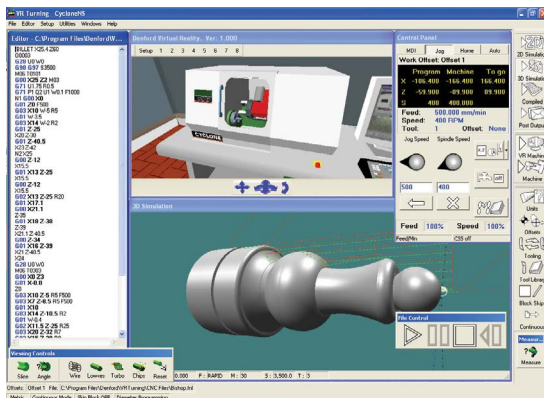

MACHINE CONTROL FEATURES

VR CNC Turning is recommended for physical control of the full range of Denford CNC Lathes. Password protected machine parameters allows tailoring to suit individual machines.

The Denford Post Processor allows translation of NC programs between different controller types.

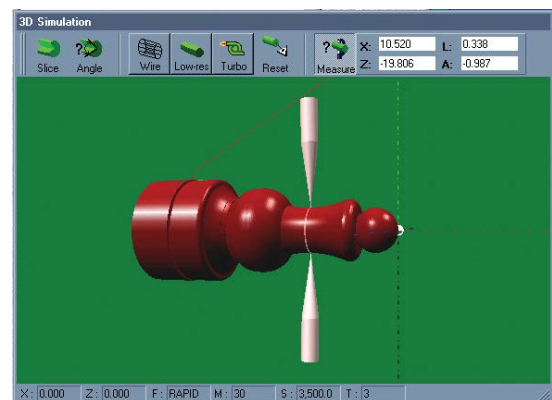

VR SIMULATION FEATURES

- Dynamic rotation/zooming.
- Colour coded move types and tooling.
- Built in Virtual Micrometer to measure the simulated workpiece.
- Unique "SourceTrack" technology for interaction between graphical data and NC Code.

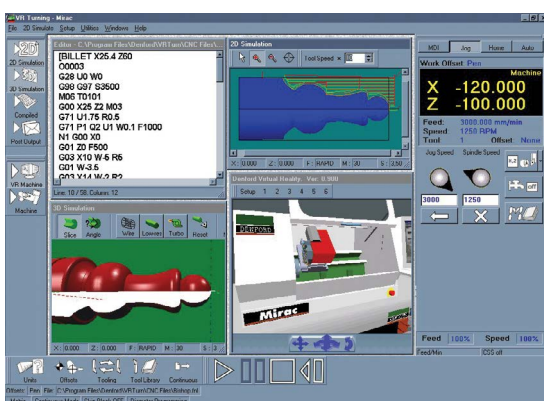

VIRTUAL REALITY FEATURES

Virtual Reality control encourages students to familiarise themselves with machining processes before physical manufacture. Includes a fully working Automatic Turret and library of machine options.

RECOMMENDED SYSTEM REQUIREMENTS

- 1 GHz Processor,
 - 1 GB Memory,
 - 32 GB Hard Disk,
 - Microsoft Windows 7, 8 & 10,
 - OpenGL Graphics Card, or built in Graphics,
- to support a minimum 1024 x 768 Screen Resolution, CNC machines require USB Connection.